

派克Manapak **CM**系列單向閥是一種疊加元件，它被用于和帶有標準化連接孔的換向閥進行疊加式連接。視功能而定，在Manapak疊加閥中的相應的流道P、T、A、B中可以配置1或2個單向閥。數量和作用方向用代號字母來規定。

**特性**

- 派克Manapak CM系列閥為鋼質閥體。
- 在閥體中8種可供選擇的單向閥的配置形式為液壓回路提供了更多的可用性。
- 假如要改變方向，可以調換定位銷并通過轉動閥體來實現。

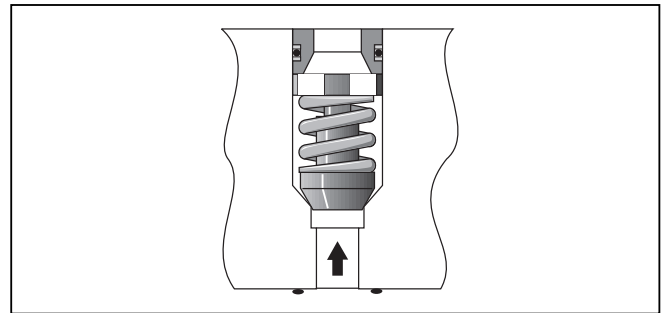
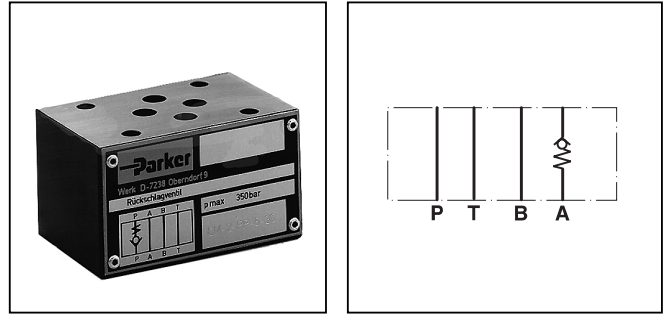

**技術參數**

	CM2	CM3
安裝形式	DIN NG6 NFFA D03 CETOP 3	DIN NG10 NFDP05 CETOP5
最大壓力	350 bar	350 bar
最大流量	53 l/min	76 l/min
開啓壓力	0.3 bar	0.3 bar
安裝位置	任意	任意
環境溫度	最大. +50°C	最大. +50°C
油液溫度	最大. +70°C	最大. +70°C
重量[kg]	0.9	1.7

**安裝說明**

有關的清潔度，液壓油，密封件以及其他用于該產品安裝和使用的建議，請參見“說明”部分。

**特性曲線**

CM2 ( $\Delta p/Q$ -特性曲線)

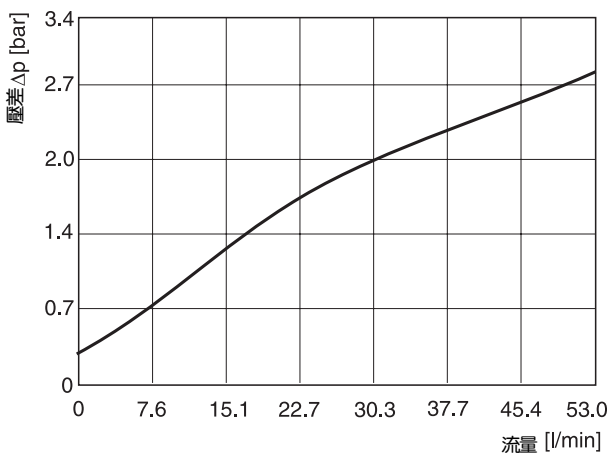

CM3 ( $\Delta p/Q$ -特性曲線)

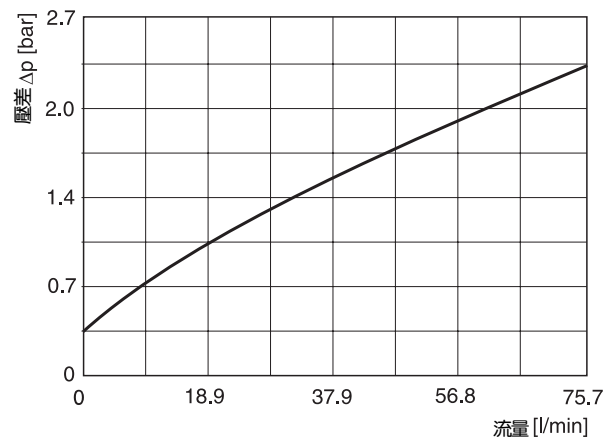

**CM**  
單向閥

閥的規格

代號	說明
2	DIN NG6
3	DIN NG10

單向閥配置

**V**  
密封件

設計系列  
(訂貨時不需要)

代號	材料
V	FPM

代號	自由流過方向	單向閥在流道:
AA	從換向閥至底板	A
BB	從換向閥至底板	B
DD	從換向閥至底板	A 和 B
PP	從底板至換向閥	P
TT	從換向閥至底板	T
AAF	從底板至換向閥	A
BBF	從底板至換向閥	B
DDF	從底板至換向閥	A 和 B

回路符號

在這些符號中，上面表示連接閥的面，下面表示帶有流道名稱的連接底板的面。

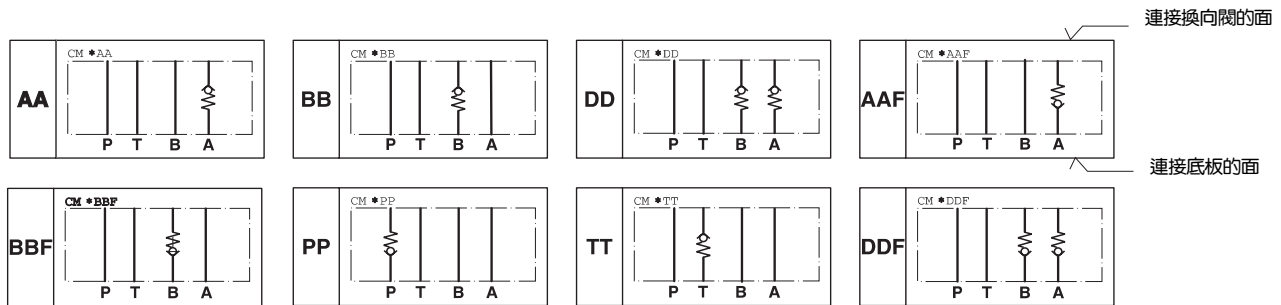

如無其它說明，公稱尺寸為 06 和 10 且結構相同的元件可以按照 Hydraulic Ring 的型號代碼進行訂貨。

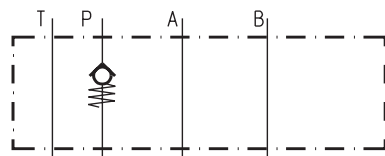
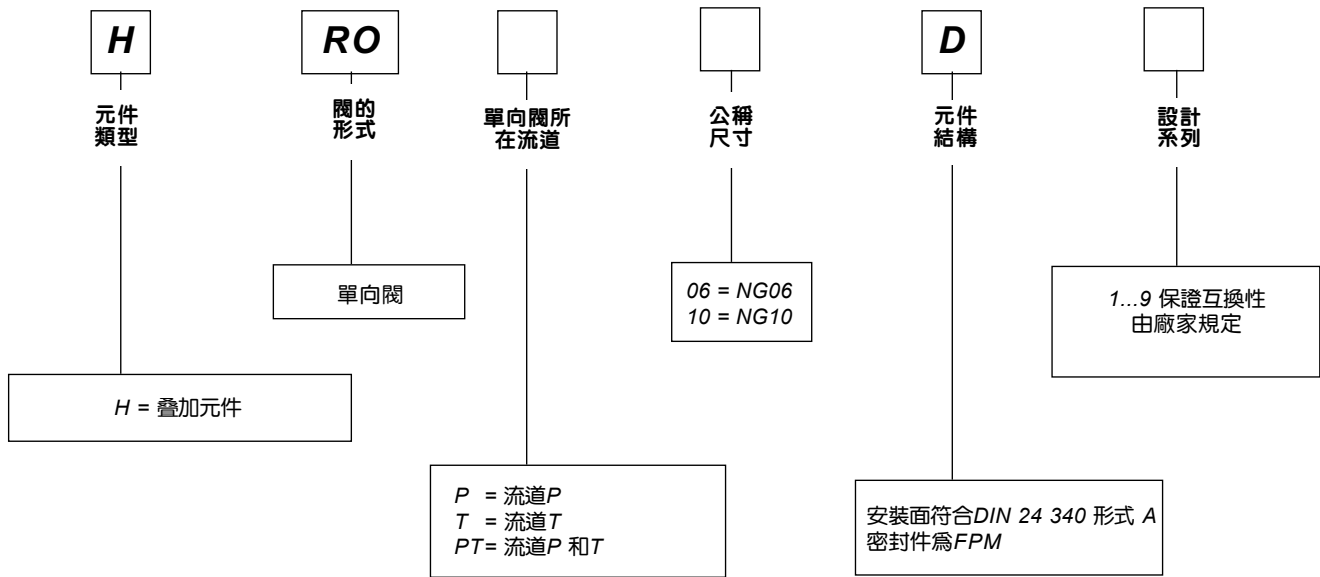

HROP 消耗裝置的壓力夾緊

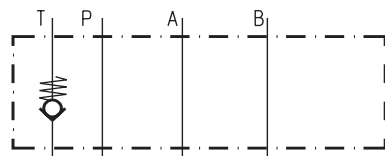

HROT 背壓或防止油壓流入

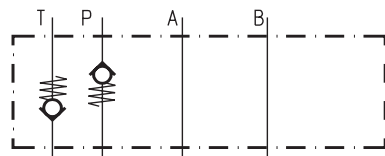

HROPT 壓力夾緊和背壓

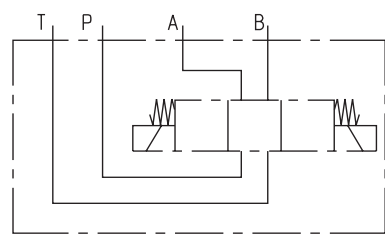

# 尺寸

## 單向閥 CM2系列

底視圖\*  
(連接底板的面)  
\*O-形圈板沒有畫!  
示圖表示的為  
TT 結構

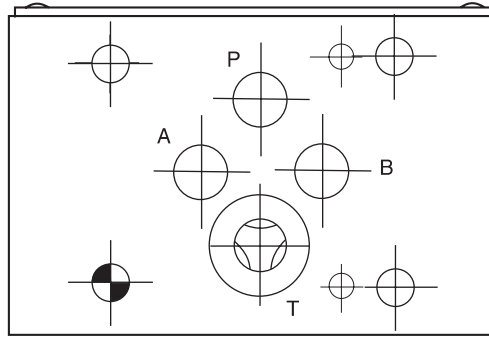

前視圖

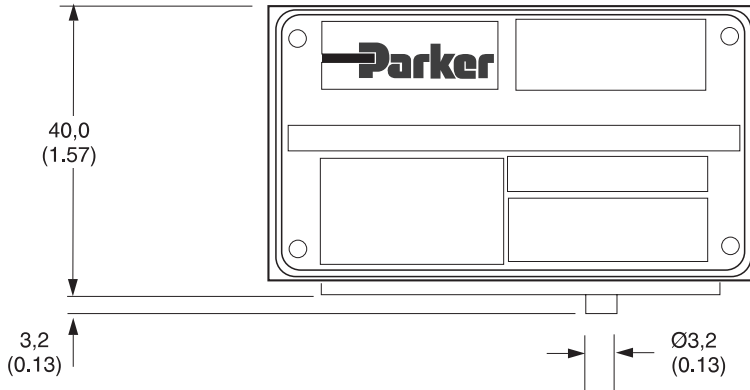

頂視圖  
(連接換向閥的面)

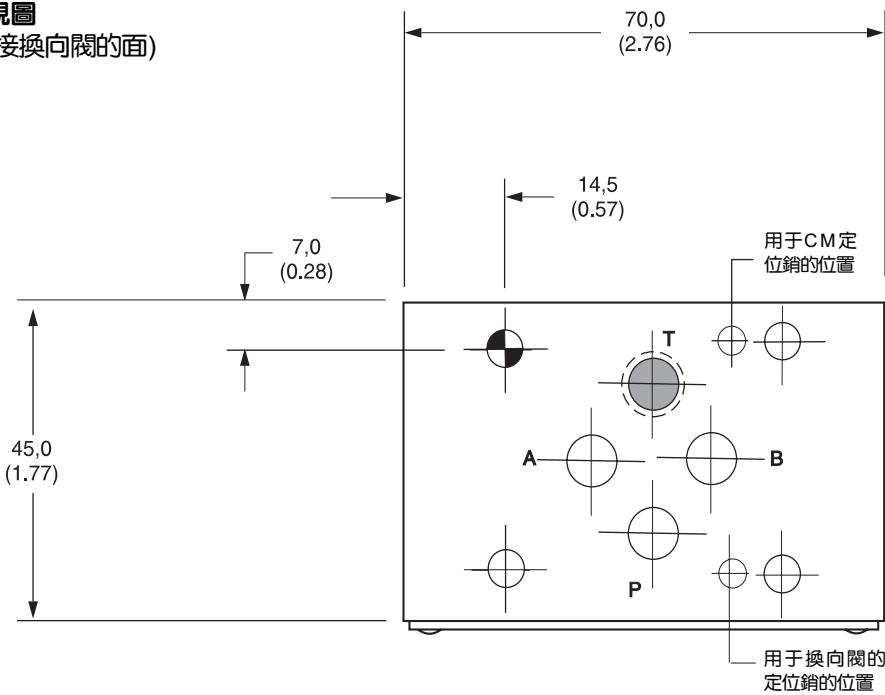

備注:

用于底板側連接面密封的O形圈板屬於供貨範圍。  
O形圈板和定位銷總是裝在連接底板的面上。

密封 - 連接底板的面 CM2			
密封件	O-形圈規格	個數	訂貨號
V	2-012	4	5001014
O-形圈板 (不帶 O-形圈)			002199

CM\_gb.PM6.5MM

從連接換向閥的面看

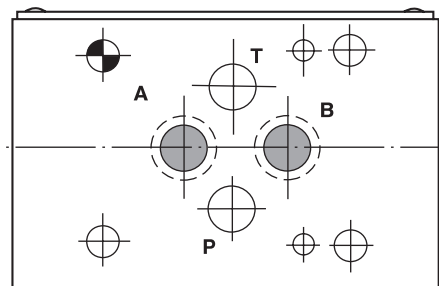
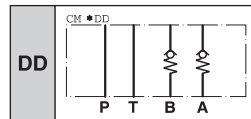
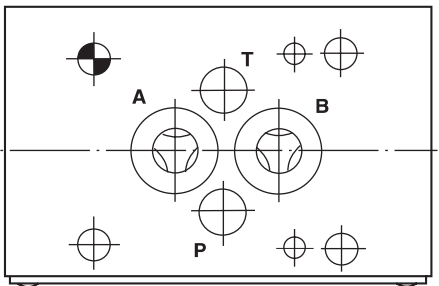
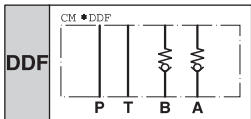
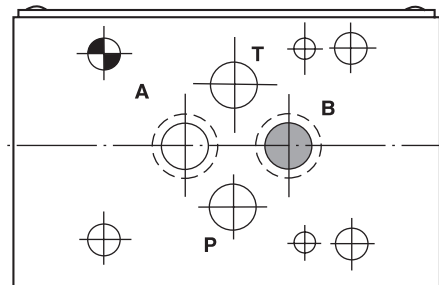
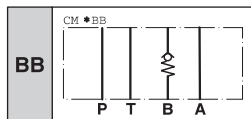
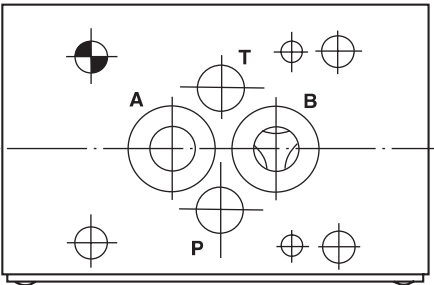
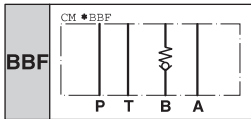
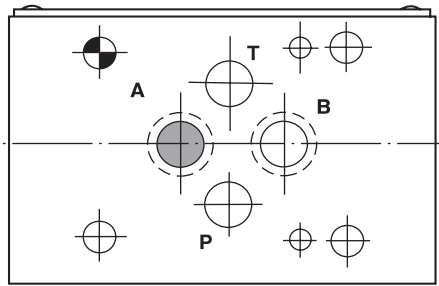
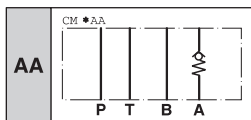
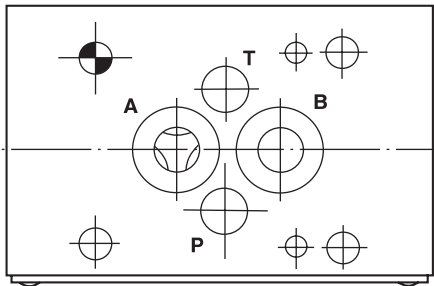
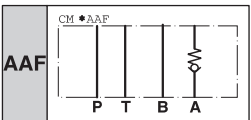
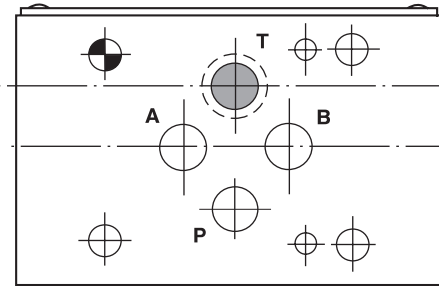
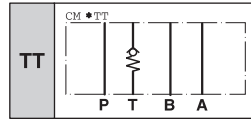
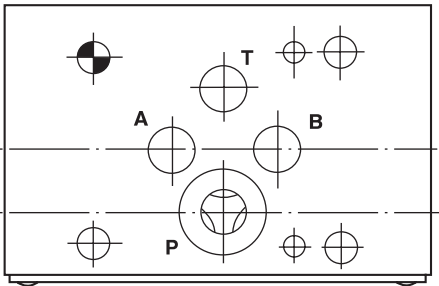
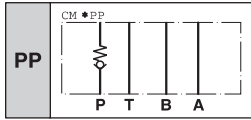

CM\_gb.PM6.5MM

單向閥  
CM3 系列

尺寸

底視圖\*  
(連接底板的面)  
\*O-形圈板沒有畫!  
示圖表示的為  
AA 結構

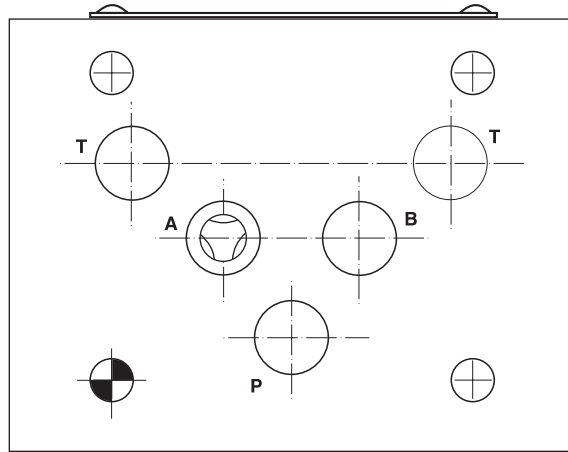

前視圖

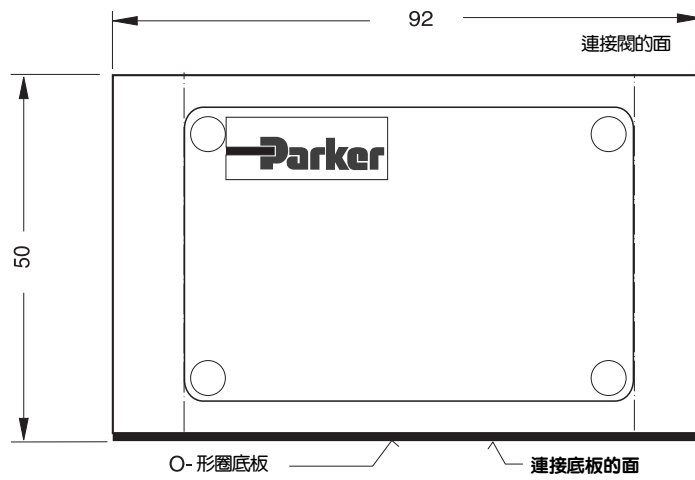

頂視圖  
(連接換向閥的面)

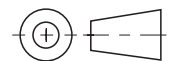
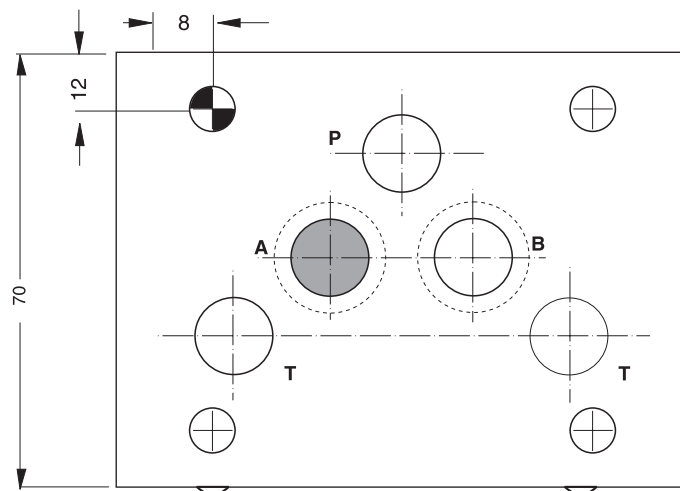

從連接換向閥的面看

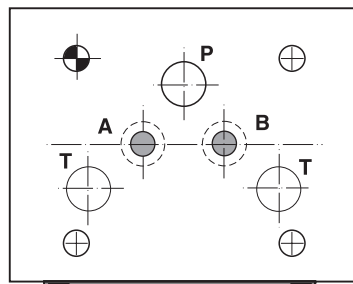
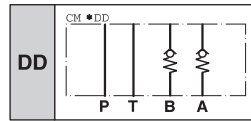
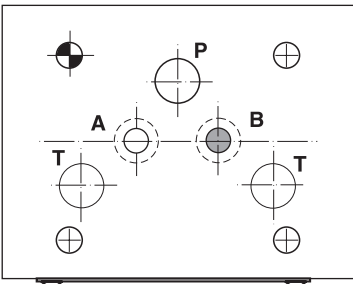
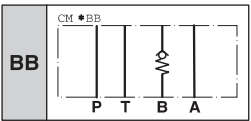
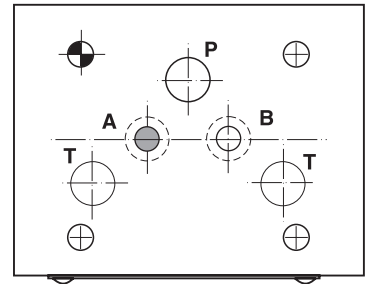
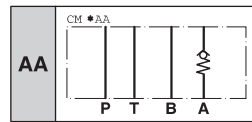
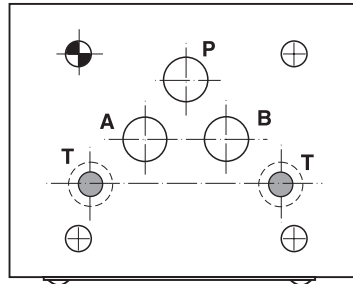
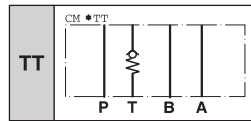
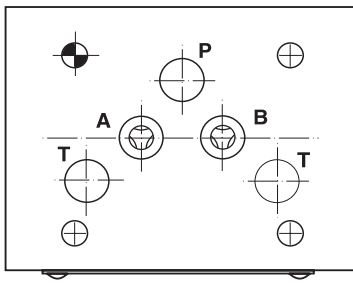
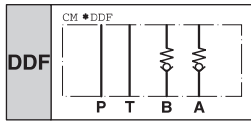
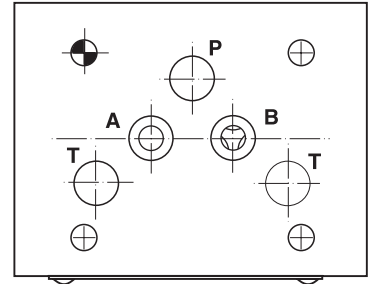
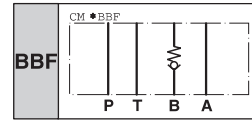
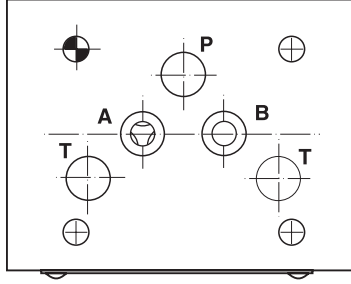
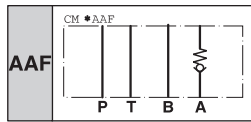
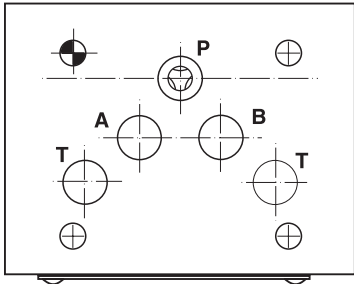
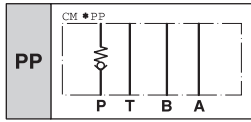

密封 - 連接底板面 CM3

密封件	O-形圈 規格	個數	訂貨代號
V	2-014	5	5001016
O-形圈板 (不帶O-形圈)			700499